

JUMO GmbH & Co. KG
 Delivery address: Mackenrodtstraße 14
 36039 Fulda, Germany
 Postal address: 36035 Fulda, Germany
 Phone: +49 661 6003-0
 Fax: +49 661 6003-607
 E-mail: mail@jumo.net
 Internet: www.jumo.net

JUMO Instrument Co. Ltd.
 JUMO House
 Temple Bank, Riverway
 Harlow - Essex CM20 2DY, UK
 Phone: +44 1279 63 55 33
 Fax: +44 1279 63 52 62
 E-mail: sales@jumo.co.uk
 Internet: www.jumo.co.uk

JUMO Process Control, Inc.
 8 Technology Boulevard
 Canastota, NY 13032, USA
 Phone: 315-697-5866
 1-800-554-JUMO
 Fax: 315-697-5867
 E-mail: info@jumo.us
 Internet: www.jumo.us



JUMO heatTHERM-AT and JUMO heatTHERM-DR

Type 603070, Surface-Mounted or Room Thermostat Versions

Special features

- **PUSH IN**-connection technology - **reduced installation time by 50 %**
- Stable switching point position due to ambient temperature compensation (standard)
- Max. switching capacity 16 A, 230 V
- Tested according to DIN EN 14597
- Operating life at least 250,000 switching cycles for TR and TW
- Switching point deviation during the entire operating life of up to $\pm 5 %$
- Protection type max. IP 54
- UL approval (extra code 061)

Brief description

High application flexibility and the latest connection technology are the essential equipment features of this new thermostat series.

The thermostat case is suitable for all common installation types such as wall mounting, immersion sleeve, and contact fastening. It can be used universally and reduces the variant range because different mounting types must no longer be taken into account.

The JUMO heatTHERM-DR (type 7+8) type is a specific variation with a special housing bottom section for DIN rail or wall mounting. As a result, easy mounting on mounting rails TH35 according to DIN EN 60715 (e.g. in control cabinets) is possible. This variant considerably reduces the mounting time. The flue gas automatic reset temperature limiter JUMO heatTHERM-AT locks the gas/oil vessel that is connected in parallel with the wood vessel to a chimney.

For these international innovative surface-mounted thermostats with "Push-In[®]" terminal technology, the connection wires are only inserted into the terminal point up to the stop - that's it! No tool is required for connecting the wire or strand with a ferrule and the wiring becomes safer. In this manner, the costs and time required for connection are considerably reduced compared to the conventional screw terminal.

The "Push-In[®]" terminal technology allows direct switching of loads up to 16 A at 230 V AC. The installation costs can be reduced further because a load contactor is no longer required.

The maintenance costs are reduced by the small distance of approx. 10 K between switch-off point and restart point of the safety temperature limiter.

Available are temperature controllers (TR), temperature monitors (TW), safety temperature monitors (STW), safety temperature limiters (STB) as single or double thermostats, and flue gas temperature monitors (ATW).

Approvals according to DIN EN 14597, DGRL, and UL indicate the high quality standards for this product series.



Type 603070/0170 (TR/STB)



Type 603070/0001 (TR)



Type 603070/0002 (TW)



Type 603070/0002 (TW)

Approvals/approval marks (see "Technical Data")



DGRL
97/23/EG



Design type 5+6*



Design type 7+8*

* Only with extra code 061

JUMO GmbH & Co. KG
 Delivery address: Mackenrodtstraße 14
 36039 Fulda, Germany
 Postal address: 36035 Fulda, Germany
 Phone: +49 661 6003-0
 Fax: +49 661 6003-607
 E-mail: mail@jumo.net
 Internet: www.jumo.net

JUMO Instrument Co. Ltd.
 JUMO House
 Temple Bank, Riverway
 Harlow - Essex CM20 2DY, UK
 Phone: +44 1279 63 55 33
 Fax: +44 1279 63 52 62
 E-mail: sales@jumo.co.uk
 Internet: www.jumo.co.uk

JUMO Process Control, Inc.
 8 Technology Boulevard
 Canastota, NY 13032, USA
 Phone: 315-697-5866
 1-800-554-JUMO
 Fax: 315-697-5867
 E-mail: info@jumo.us
 Internet: www.jumo.us



Technical data

Switching function

Temperature controller TR / temperature monitor TW	<p>If the temperature on the temperature probe exceeds the setpoint value, the microswitch is activated by the transmission mechanics and the electrical circuit is opened or closed.</p> <p>If the temperature falls below the selected setpoint value (by the amount of the switching differential), the microswitch is reset to its initial position.</p>
Safety temperature monitor STW	<p>If the temperature on the temperature probe exceeds the setpoint value, the snap-action switch is activated and the electrical circuit is opened or closed. If the temperature falls below the selected setpoint value (by the amount of the switching differential), the snap-action switch is reset to its initial position.</p> <p>If the probe has cooled down to a temperature below approx. -20 °C the same electrical circuit opens - however it closes again when the temperature rises.</p> <p>If the measuring system is destroyed (i.e. if the expansion fluid emerges) the pressure in the diaphragm drops and permanently opens the electrical circuit.</p>
Safety temperature limiter STB	<p>If the temperature on the temperature probe exceeds the switching point, the snap-action switch is activated, the electrical circuit is opened or closed, and the snap-action switch is mechanically locked.</p> <p>The snap-action switch can be manually unlocked again once the switching point temperature has dropped by approx. 10 K.</p> <p>If the probe has cooled down to a temperature below approx. -20 °C the electrical circuit opens - however it closes again when the temperature rises.</p> <p>If the measuring system is destroyed (i.e. if the expansion fluid emerges) the pressure in the diaphragm drops and permanently opens the electrical circuit. Unlocking is no longer possible.</p>

Temperature compensation

When the ambient temperature on the switching head and the capillary deviates — from the calibration ambient temperature of +22 °C — a switching point offset occurs. This switching point offset is reduced to a minimum due to the temperature compensation.

JUMO GmbH & Co. KG
 Delivery address: Mackenrodtstraße 14
 36039 Fulda, Germany
 Postal address: 36035 Fulda, Germany
 Phone: +49 661 6003-0
 Fax: +49 661 6003-607
 E-mail: mail@jumo.net
 Internet: www.jumo.net

JUMO Instrument Co. Ltd.
 JUMO House
 Temple Bank, Riverway
 Harlow - Essex CM20 2DY, UK
 Phone: +44 1279 63 55 33
 Fax: +44 1279 63 52 62
 E-mail: sales@jumo.co.uk
 Internet: www.jumo.co.uk

JUMO Process Control, Inc.
 8 Technology Boulevard
 Canastota, NY 13032, USA
 Phone: 315-697-5866
 1-800-554-JUMO
 Fax: 315-697-5867
 E-mail: info@jumo.us
 Internet: www.jumo.us



Technical data

Case

	Type 5 + 6	Type 7 + 8
Case	Case bottom section: Color: Cobalt-blue RAL 5013 (for TZ 061 light-gray, RAL 7035) Case lid: ABS with inspection glass (PMMA) Color: Cobalt-blue RAL 5013 (for TZ 061 light-gray, RAL 7035)	PA (reinforced) Color: Silver-gray RAL 7001 (for TZ 061 black)
Setpoint adjustment	TR Switching point can be adjusted externally with the rotary knob. TW, STW, STB, ATW Switching point can be adjusted with a screwdriver once the case lid has been removed. The set switching point can be checked through the inspection glass.	- - Switching point can be adjusted with a screwdriver.
Protection type	IP 54 according to EN 60 529	IP 20 according to EN 60 529
Cable inlet	Cable gland M20 x 1.5, for cable-Ø 6-12 mm	Cable connection directly on PUSH IN terminals
Capillary	Ø 1.5 mm - min. bending radius of the capillary 5 mm - material: Copper (Cu) or stainless steel (CrNi, 1.4301)	
Case fastening	Pipe mounting with clamping belt for pipe diameter 15-100 mm, thermowell mounting, wall mounting	Wall mounting, DIN rail installation TH35 according to DIN EN 60715
Weight	Approx. 0.2 kg	

Electrical data

Electric contact	Snap-action switch with single-pole changeover contact	
Switching capacity	TR / TW / STW / ATW On the N/C contact (contact deck 1-2): AC 230 V +10 %, 16 (2.5) A, cos φ = 1 (0.6), DC 230 V +10 %, 0.25 A On the N/O contact (contact deck 1-4): AC 230 V +10 %, 6.3 (2.5) A, cos φ = 1 (0.6), DC 230 V +10 %, 0.25 A	STB On the N/C contact (contact deck 1-2): AC 230 V +10 %, 16 (2.5) A, cos φ = 1 (0.6), DC 230 V +10 %, 0.25 A On the signal contact (contact deck 1-4): AC 230 V +10 %, 2 (0.4) A, cos φ = 1 (0.6), DC 230 V +10 %, 0.25 A
Electrical connection	PUSH IN contact (plug-type terminal) "Push-In [®] " terminal technology: Patented connection technology by Weidmüller GmbH & Co. KG, Detmold, Germany	
Connection cross section	0.75 to 2.5 mm ² fine wired (single-wire, fine wired with ferrule)	
Switching reliability	To ensure the greatest possible switching reliability, we recommend a minimum load of: AC / DC = 24 V, 100 mA for silver contacts AC / DC = 10 V, 5 mA for gold-plated contacts (TZ 702)	

JUMO GmbH & Co. KG
 Delivery address: Mackenrodtstraße 14
 36039 Fulda, Germany
 Postal address: 36035 Fulda, Germany
 Phone: +49 661 6003-0
 Fax: +49 661 6003-607
 E-mail: mail@jumo.net
 Internet: www.jumo.net

JUMO Instrument Co. Ltd.
 JUMO House
 Temple Bank, Riverway
 Harlow - Essex CM20 2DY, UK
 Phone: +44 1279 63 55 33
 Fax: +44 1279 63 52 62
 E-mail: sales@jumo.co.uk
 Internet: www.jumo.co.uk

JUMO Process Control, Inc.
 8 Technology Boulevard
 Canastota, NY 13032, USA
 Phone: 315-697-5866
 1-800-554-JUMO
 Fax: 315-697-5867
 E-mail: info@jumo.us
 Internet: www.jumo.us



Operating data

Switching point accuracy	TR, TW	STW, STB with a setting range of:			
		+20 °C to +80 °C		+70 °C to +130 °C	
	Switching differential 2.5%	In the "first half" (+20 °C to +50 °C)	In the "second half" (+50 °C to +80 °C)	In the "first half" (+70 °C to +100 °C)	In the "second half" (+100 °C to +130 °C)
	In the upper third of the scale $\pm 3\%$, at scale beginning $\pm 6\%$	+0/-8 K	+0/-5 K	+0/-12 K	+0/-5 K
Temperature compensation	When the ambient temperature on the switching head and the capillary deviates — from the calibration ambient temperature of +22 °C — a switching point offset of approx. -0.1 K/K occurs (switching point change referring to the ambient temperature change, measured at limit value +120 °C permanently set and capillary length 2,000 mm). This switching point offset is reduced to a minimum due to the standard temperature compensation.				
Limit value temperatures	For transport and storage: -30 °C to +50 °C				
	During use: Max. +80 °C, for TZ 061 UL approval max. +65 °C (type 7 max. 55 °C; type 6+8 max. +50 °C)				
	For pipe mounting: Max. pipe temperature +120 °C				
Rated position	According to DIN 16257, rated position 0 to rated position 90 (different rated positions upon request)				

Approvals/approval marks

Approval marks	Inspection authority	Certificates/certification number	Inspection basis	Valid for
DIN	DIN CERTCO	TR 119107	DIN EN 14597	TR 119107, TW 119207, STW (STB) 119307, STB 119407, ATW 1218
DIN	TÜV Süd (German Technical Inspection Agency)	DIN EN ISO 13849-1	B _{10d} = 250,000*	JUMO heatTHERM-AT/-DR
DGRL	TÜV Süd (German Technical Inspection Agency)	IS-TAF-MUC 07113377017	Pressure Equipment Directive 97/23/EC	STW and STB
UL	UL Germany	E 66358	UL 873	JUMO heatTHERM-DR

* For further details see: Safety manual JUMO heatTHERM (-AT), (-DR) 602031, 603070.
 Contact rating check conducted at 16 A, 230 V, resistive load.

Wiring diagrams

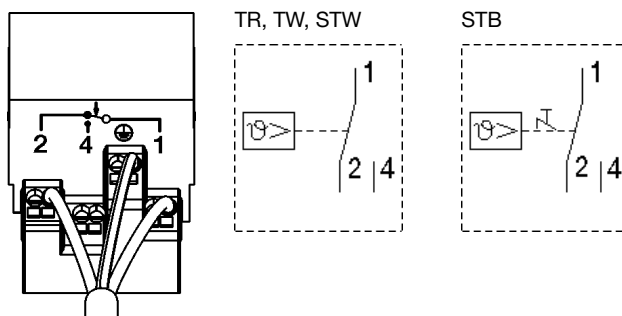

JUMO GmbH & Co. KG
 Delivery address: Mackenrodtstraße 14
 36039 Fulda, Germany
 Postal address: 36035 Fulda, Germany
 Phone: +49 661 6003-0
 Fax: +49 661 6003-607
 E-mail: mail@jumo.net
 Internet: www.jumo.net

JUMO Instrument Co. Ltd.
 JUMO House
 Temple Bank, Riverway
 Harlow - Essex CM20 2DY, UK
 Phone: +44 1279 63 55 33
 Fax: +44 1279 63 52 62
 E-mail: sales@jumo.co.uk
 Internet: www.jumo.co.uk

JUMO Process Control, Inc.
 8 Technology Boulevard
 Canastota, NY 13032, USA
 Phone: 315-697-5866
 1-800-554-JUMO
 Fax: 315-697-5867
 E-mail: info@jumo.us
 Internet: www.jumo.us



Devices in stock: JUMO heatTHERM-AT

Temperature controller TR, type 5

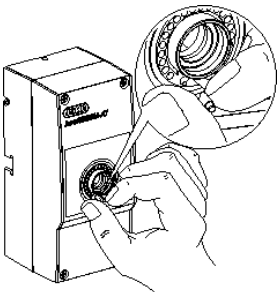
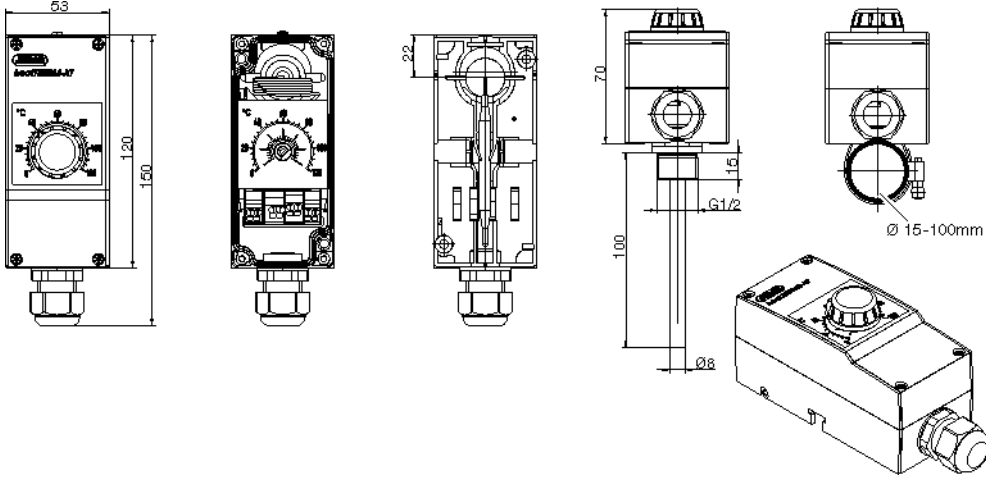
Type 603070/0001^a <ul style="list-style-type: none"> Protection type IP 54 Compensation of the ambient temperature Individual limitation of the control range 						
Part no.	Type	Control range °C	Capillary mm	Probe-Ø (d) × L mm	Switching differential	Process connection
60003185	JUMO	0 to +120	2000	6 × 87	Approx. 3 K	With internal capillary and contact probe
60003186	heatTHERM-AT/0001					Thermowell U 4, brass nickel-plated

^a Further design versions (control range, switching differential, process connection) upon request - minimum order quantity 100 pieces. Thermowells page 15.

Temperature monitor TW

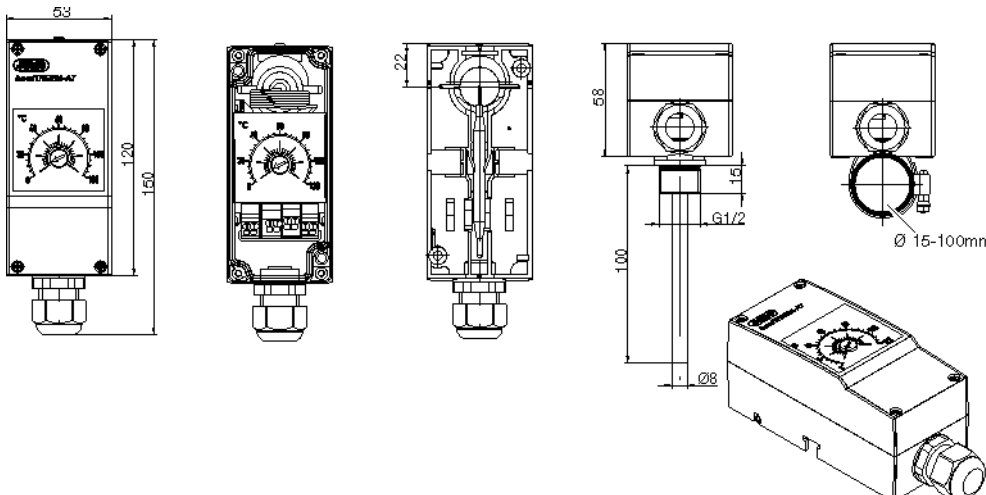
Type 603070/0002^a <ul style="list-style-type: none"> Protection type IP 54 Compensation of the ambient temperature Switching value check through inspection window in the case lid 						
Part no.	Type	Control range °C	Capillary mm	Probe-Ø (d) × L mm	Switching differential	Process connection
60003187	JUMO	0 to +120	2000	6 × 87	Approx. 3 K	With internal capillary and contact probe
60003188	heatTHERM-AT/0002					Thermowell U 4, brass nickel-plated

^a Further design versions (control range, switching differential, process connection) upon request - minimum order quantity 100 pieces. Thermowells page 15.

JUMO GmbH & Co. KG
 Delivery address: Mackenrodtstraße 14
 36039 Fulda, Germany
 Postal address: 36035 Fulda, Germany
 Phone: +49 661 6003-0
 Fax: +49 661 6003-607
 E-mail: mail@jumo.net
 Internet: www.jumo.net

JUMO Instrument Co. Ltd.
 JUMO House
 Temple Bank, Riverway
 Harlow - Essex CM20 2DY, UK
 Phone: +44 1279 63 55 33
 Fax: +44 1279 63 52 62
 E-mail: sales@jumo.co.uk
 Internet: www.jumo.co.uk

JUMO Process Control, Inc.
 8 Technology Boulevard
 Canastota, NY 13032, USA
 Phone: 315-697-5866
 1-800-554-JUMO
 Fax: 315-697-5867
 E-mail: info@jumo.us
 Internet: www.jumo.us



Devices in stock: JUMO heatTHERM-AT

Safety temperature monitor STW, type 5

Type 603070/0020^a <ul style="list-style-type: none"> Protection type IP 54 Switching value check through inspection window in the case lid Compensation of the ambient temperature Subsequent sealing of the case lid is possible Capillary break protection 						
Part no.	Type	Control range °C	Capillary mm	Probe-∅ (d) × L mm	Switching differential	Process connection
60003229	JUMO	+20 to +80	2000	6 x 60	Approx. 10 K	With internal capillary and contact probe
60003189	heatTHERM-AT/0020	+70 to +130				Thermowell U 4, brass nickel-plated

^a Further design versions (control range, switching differential, process connection) upon request - minimum order quantity 100 pieces. Thermowells page 15.

Safety temperature limiter STB, type 5

Type 603070/0070^a <ul style="list-style-type: none"> Protection type IP 54 Switching value check through inspection window in the case lid External acknowledgement of the switching point is possible Compensation of the ambient temperature Subsequent sealing of the case lid is possible Capillary break protection 						
Part no.	Type	Control range °C	Capillary mm	Probe-∅ (d) × L mm	Switching differential	Process connection
60003230	JUMO	+70 to +130	2000	6 x 60	Approx. 10 K	With internal capillary and contact probe
60003190	heatTHERM-AT/0070					Thermowell U 4, brass nickel-plated

^a Further design versions (control range, switching differential, process connection) upon request - minimum order quantity 100 pieces. Thermowells page 15.

JUMO GmbH & Co. KG
 Delivery address: Mackenrodtstraße 14
 36039 Fulda, Germany
 Postal address: 36035 Fulda, Germany
 Phone: +49 661 6003-0
 Fax: +49 661 6003-607
 E-mail: mail@jumo.net
 Internet: www.jumo.net

JUMO Instrument Co. Ltd.
 JUMO House
 Temple Bank, Riverway
 Harlow - Essex CM20 2DY, UK
 Phone: +44 1279 63 55 33
 Fax: +44 1279 63 52 62
 E-mail: sales@jumo.co.uk
 Internet: www.jumo.co.uk

JUMO Process Control, Inc.
 8 Technology Boulevard
 Canastota, NY 13032, USA
 Phone: 315-697-5866
 1-800-554-JUMO
 Fax: 315-697-5867
 E-mail: info@jumo.us
 Internet: www.jumo.us



Devices in stock: JUMO heatTHERM-AT

Room thermostat temperature controller TR, type 6

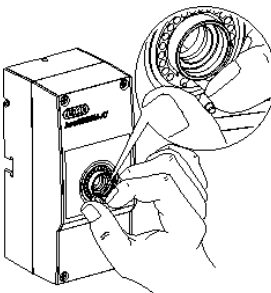
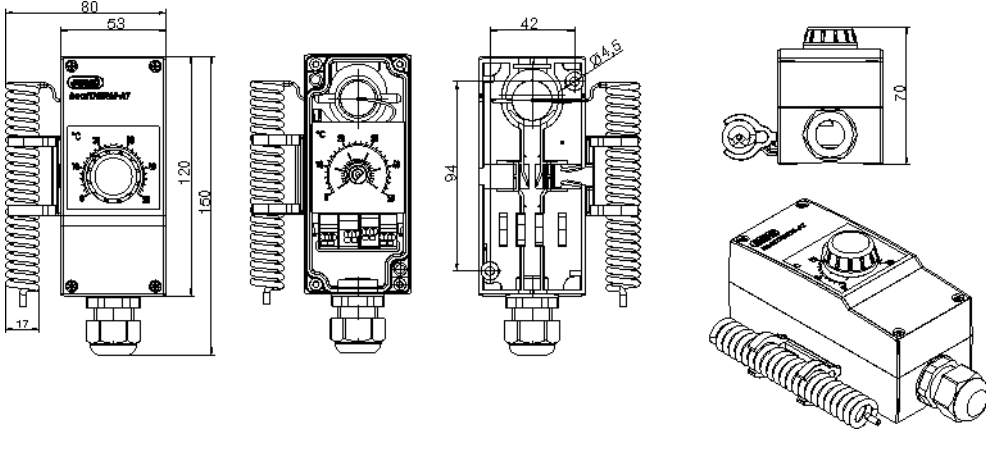
Type 603070/0001^a <ul style="list-style-type: none"> Protection type IP 54 Wall mounting Individual limitation of the control range 						
Part no.	Type	Control range °C	Capillary mm	Probe-Ø (d) x L mm	Switching differential	Process connection
60003191	JUMO	-10 to +40	--	--	1.5 - 2 K	Spiral probe
60003192	heatTHERM-AT/0001	0 to +50				

^a Further design versions (control range, switching differential, process connection) upon request - minimum order quantity 100 pieces. Thermowells page 15.

Room thermostat temperature limiter TW, type 6

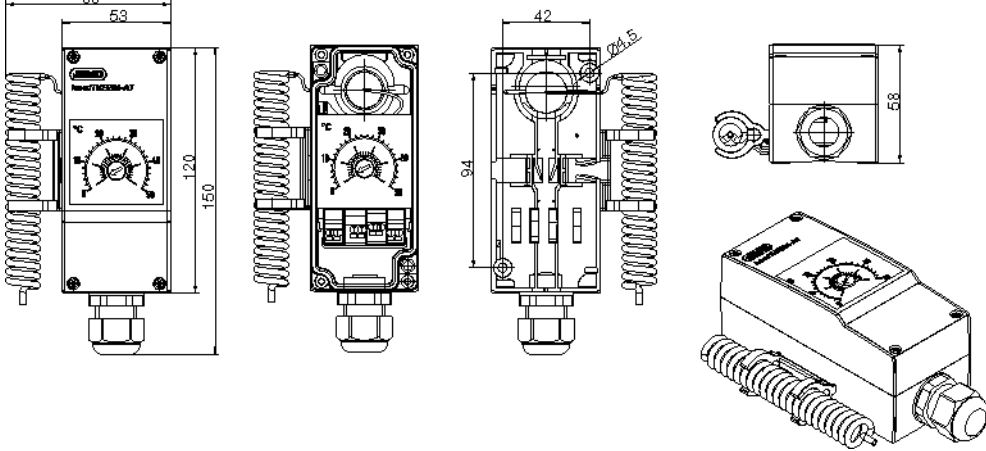
Type 603070/0002^a <ul style="list-style-type: none"> Protection type IP 54 Wall mounting Switching value check through inspection window in the case lid 						
Part no.	Type	Control range °C	Capillary mm	Probe-Ø (d) x L mm	Switching differential	Process connection
60003193	JUMO	-10 to +40	--	--	1.5 - 2 K	Spiral probe
60003194	heatTHERM-AT/0002	0 to +50				

^a Further design versions (control range, switching differential, process connection) upon request - minimum order quantity 100 pieces. Thermowells page 15.

JUMO GmbH & Co. KG
 Delivery address: Mackenrodtstraße 14
 36039 Fulda, Germany
 Postal address: 36035 Fulda, Germany
 Phone: +49 661 6003-0
 Fax: +49 661 6003-607
 E-mail: mail@jumo.net
 Internet: www.jumo.net

JUMO Instrument Co. Ltd.
 JUMO House
 Temple Bank, Riverway
 Harlow - Essex CM20 2DY, UK
 Phone: +44 1279 63 55 33
 Fax: +44 1279 63 52 62
 E-mail: sales@jumo.co.uk
 Internet: www.jumo.co.uk

JUMO Process Control, Inc.
 8 Technology Boulevard
 Canastota, NY 13032, USA
 Phone: 315-697-5866
 1-800-554-JUMO
 Fax: 315-697-5867
 E-mail: info@jumo.us
 Internet: www.jumo.us



Devices in stock: JUMO heatTHERM-AT

Temperature controller / safety temperature monitor TR/STW, type 5

Type 603070/0120^a <ul style="list-style-type: none"> Protection type IP 54 Switching value check through inspection window in the case lid Compensation of the ambient temperature Capillary break protection for STW 						
Part no.	Type	Control range °C	Capillary mm	Probe-Ø (d) x L mm	Switching differential	Process connection
60003195	JUMO heatTHERM-AT/0120	TR: 0 to +120	2000	6 x 87	Approx. 3 K	With internal capillary and contact probe
		STW: 70 to +130		6 x 60	Approx. 10 K	
60003231		TR: 0 to +120		6 x 87	Approx. 3 K	Thermowell; brass nickel-plated
		STW: 70 to +130		6 x 60	Approx. 10 K	

^a Further design versions (control range, switching differential, process connection) upon request - minimum order quantity 100 pieces. Thermowells page 15.

Temperature controller / safety temperature limiter TR/STB, type 5

Type 603070/0170^a <ul style="list-style-type: none"> Protection type IP 54 Switching value check through inspection window in the case lid Compensation of the ambient temperature Capillary break protection for STW 						
Part no.	Type	Control range °C	Capillary mm	Probe-Ø (d) x L mm	Switching differential	Process connection
60003196	JUMO heatTHERM-AT/0170	TR: 0 to +120	2000	6 x 87	Approx. 3 K	With internal capillary and contact probe
		STB: 70 to +130		6 x 60	Approx. 10 K	
60003232		TR: 0 to +120		6 x 87	Approx. 3 K	Thermowell; brass nickel-plated
		STB: 70 to +130		6 x 60	Approx. 10 K	

^a Further design versions (control range, switching differential, process connection) upon request - minimum order quantity 100 pieces. Thermowells page 15.

JUMO GmbH & Co. KG
 Delivery address: Mackenrodtstraße 14
 36039 Fulda, Germany
 Postal address: 36035 Fulda, Germany
 Phone: +49 661 6003-0
 Fax: +49 661 6003-607
 E-mail: mail@jumo.net
 Internet: www.jumo.net

JUMO Instrument Co. Ltd.
 JUMO House
 Temple Bank, Riverway
 Harlow - Essex CM20 2DY, UK
 Phone: +44 1279 63 55 33
 Fax: +44 1279 63 52 62
 E-mail: sales@jumo.co.uk
 Internet: www.jumo.co.uk

JUMO Process Control, Inc.
 8 Technology Boulevard
 Canastota, NY 13032, USA
 Phone: 315-697-5866
 1-800-554-JUMO
 Fax: 315-697-5867
 E-mail: info@jumo.us
 Internet: www.jumo.us



Devices in stock: JUMO heatTHERM-AT

Room thermostat temperature monitor / temperature monitor TW/TW, type 6

Type 603070/0202^a <ul style="list-style-type: none"> Protection type IP 54 Wall mounting Switching value control through inspection window in the case lid 						
Part no.	Type	Control range °C	Capillary mm	Probe-Ø (d) x L mm	Switching differential	Process connection
60003212	JUMO heatTHERM-AT/0202	-10 to +40	--	--	1.5 - 2 K	Spiral probe
60003213	JUMO heatTHERM-AT/0202	0 to +50	--	--	1.5 - 2 K	Spiral probe

^a Further design versions (control range, switching differential, process connection) upon request - minimum order quantity 100 pieces. Thermowells page 15.

Flue gas temperature monitor with flange sleeve, design 5

Type 603070/0020^a <ul style="list-style-type: none"> Switching value check through inspection window in the case lid Compensation of the ambient temperature Max. allowable probe temperature +400 °C Approval as ATW with capillary break protection according to DIN EN 14597 Time constant $t_{0.632} \leq 45$ sec. in flue gas 						
Part no.	Type	Control range °C	Capillary mm	Probe-Ø (d) x L mm	Switching differential	Process connection
60003307	JUMO heatTHERM-AT/0020	+40 to +230	--	--	Approx. 15 K	Thermowell with flange and intermediate piece

^a Further design versions (control range, switching differential, process connection) upon request - minimum order quantity 100 pieces. Thermowells page 15.

JUMO GmbH & Co. KG
 Delivery address: Mackenrodtstraße 14
 36039 Fulda, Germany
 Postal address: 36035 Fulda, Germany
 Phone: +49 661 6003-0
 Fax: +49 661 6003-607
 E-mail: mail@jumo.net
 Internet: www.jumo.net



JUMO Instrument Co. Ltd.
 JUMO House
 Temple Bank, Riverway
 Harlow - Essex CM20 2DY, UK
 Phone: +44 1279 63 55 33
 Fax: +44 1279 63 52 62
 E-mail: sales@jumo.co.uk
 Internet: www.jumo.co.uk

JUMO Process Control, Inc.
 8 Technology Boulevard
 Canastota, NY 13032, USA
 Phone: 315-697-5866
 1-800-554-JUMO
 Fax: 315-697-5867
 E-mail: info@jumo.us
 Internet: www.jumo.us

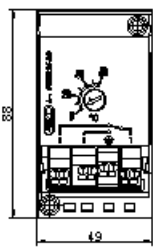

Devices in stock: JUMO heatTHERM-DR

Thermostat for DIN rail installation TH35, according to DIN EN 60715, type 7

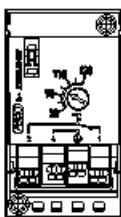
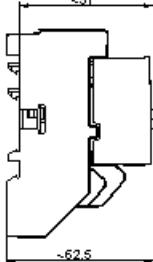
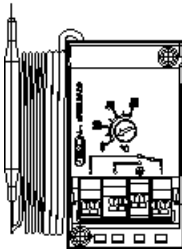
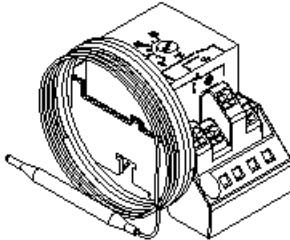
Type 603070/....^a <ul style="list-style-type: none"> Protection type IP 20 DIN rail installation TH35 Easy to assemble and user friendly 	603070/0002-7 		603070/0020-7 		603070/0070-7 		
							

Part no.	Type	Control range °C	Capillary mm	Probe-∅ (d) × L mm	Switching differential	Process connection
Temperature monitor TW						
60003283	603070/0002	0 to +120	2000	6 × 87	Approx. 3K	With capillary and contact probe
60003284	603070/0002	0 to +200		6 × 78	Approx. 5 K	
60003285	603070/0002	+50 to +300		6 × 66	Approx. 6 K	
Safety temperature monitor STW						
60003286	603070/0020	+70 to +130	2000	6 × 60	Approx. 10 K	With capillary and contact probe
Safety temperature limiter STB					Unlocking difference	
60003287	603070/0070	+70 to +130	2000	6 × 60	Approx. 10 K	With capillary and contact probe
60003299	603070/0070	+20 to +150		6 × 63		
60003300	603070/0070	+50 to +300		6 × 63		

^a Further design versions (control range, switching differential, process connection) upon request - minimum order quantity 100 pieces. Thermowells page 15.

JUMO GmbH & Co. KG
 Delivery address: Mackenrodtstraße 14
 36039 Fulda, Germany
 Postal address: 36035 Fulda, Germany
 Phone: +49 661 6003-0
 Fax: +49 661 6003-607
 E-mail: mail@jumo.net
 Internet: www.jumo.net

JUMO Instrument Co. Ltd.
 JUMO House
 Temple Bank, Riverway
 Harlow - Essex CM20 2DY, UK
 Phone: +44 1279 63 55 33
 Fax: +44 1279 63 52 62
 E-mail: sales@jumo.co.uk
 Internet: www.jumo.co.uk

JUMO Process Control, Inc.
 8 Technology Boulevard
 Canastota, NY 13032, USA
 Phone: 315-697-5866
 1-800-554-JUMO
 Fax: 315-697-5867
 E-mail: info@jumo.us
 Internet: www.jumo.us



JUMO heatTHERM-DR

Thermostat for DIN rail installation TH35, according to DIN EN 60715, type 8

<p>Type 603070/0002-8^a</p> <ul style="list-style-type: none"> • Protection type IP 20 • DIN rail installation TH35 • Easy to assemble and user friendly <p>Fastening hole (1) = Ø 4.5 mm</p>	<p>603070/0002-8</p>	<p>603070/0020-8</p>	<p>603070/0070-8</p>	
--	----------------------	----------------------	----------------------	--

^a Upon request - minimum order quantity 100 pieces.

JUMO GmbH & Co. KG
 Delivery address: Mackenrodtstraße 14
 36039 Fulda, Germany
 Postal address: 36035 Fulda, Germany
 Phone: +49 661 6003-0
 Fax: +49 661 6003-607
 E-mail: mail@jumo.net
 Internet: www.jumo.net

JUMO Instrument Co. Ltd.
 JUMO House
 Temple Bank, Riverway
 Harlow - Essex CM20 2DY, UK
 Phone: +44 1279 63 55 33
 Fax: +44 1279 63 52 62
 E-mail: sales@jumo.co.uk
 Internet: www.jumo.co.uk





JUMO Process Control, Inc.
 8 Technology Boulevard
 Canastota, NY 13032, USA
 Phone: 315-697-5866
 1-800-554-JUMO
 Fax: 315-697-5867
 E-mail: info@jumo.us
 Internet: www.jumo.us



Order details

Surface-mounted thermostat JUMO heatTHERM, type 603070

Minimum purchase order 100 pieces

Order code	(1)	Basic type	
603070		JUMO heatTHERM with single-pole snap-action switch	
	(2)	Basic type extension	
0001		Temperature controller (TR)	
0002		Temperature monitor (TW)	
0020		Safety temperature monitor (STW) or flue gas temperature monitor (ATW)	
0070		Safety temperature limiter (STB)	
0120		Temperature controller / safety temperature monitor (TR/STW)	
0170		Temperature controller / safety temperature limiter (TR/STB)	
0202		Temperature monitor / temperature monitor (TW/TW)	
	(3)	Type	
5		Surface-mounted thermostat, with thermowell, flange sleeve, capillary, or as contact probe	
6		Room thermostat with spiral probe	
7		DIN rail thermostat, with capillary	
8		DIN rail thermostat, with spiral probe	
	(4)	Control range / limit value range 1 [°C]	
016		-10 to +40	TR, TW
021		0 to +50	TR, TW
026		0 to +120	TR, TW
028		0 to +200	TR, TW, STB
040		+20 to +80	STW
043		+20 to +150	TR, TW, STB
064		+50 to +300	TR, TW, STB With thermowell, select process connection 76
671		+70 to +130	STW, STB
380		+40 to +230	ATW Only with process connection 35
		Further control ranges / limit value ranges up to 350 °C upon request (up to +500 °C without approval)	
	(5)	Control range / limit value range 2 [°C]	
000		With permanently set limit value (single thermostat)	
016		-10 to +40	TR, TW Adjustable
021		0 to +50	TR, TW Adjustable
671		+70 to +130	STW, STB Adjustable
		Further control values / limit values permanently set up to 350 °C upon request (up to +500 °C without approval)	

JUMO GmbH & Co. KG
 Delivery address: Mackenrodtstraße 14
 36039 Fulda, Germany
 Postal address: 36035 Fulda, Germany
 Phone: +49 661 6003-0
 Fax: +49 661 6003-607
 E-mail: mail@jumo.net
 Internet: www.jumo.net





JUMO Instrument Co. Ltd.
 JUMO House
 Temple Bank, Riverway
 Harlow - Essex CM20 2DY, UK
 Phone: +44 1279 63 55 33
 Fax: +44 1279 63 52 62
 E-mail: sales@jumo.co.uk
 Internet: www.jumo.co.uk

JUMO Process Control, Inc.
 8 Technology Boulevard
 Canastota, NY 13032, USA
 Phone: 315-697-5866
 1-800-554-JUMO
 Fax: 315-697-5867
 E-mail: info@jumo.us
 Internet: www.jumo.us

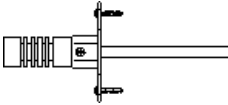

Order details

Surface-mounted thermostat JUMO heatTHERM, type 603070

Order code	(6)	Switching differential 1	
00		Without switching differential (STB)	
25		2.5 %	of the scale range
70		7 %	of the scale range
	(7)	Switching differential 2	
00		Without switching differential (STB)	
25		2.5 %	of the scale range
70		7 %	of the scale range
	(8)	Capillary length 1	
0		0 mm	only for room thermostat
2000		2000 mm	
			Special length upon request
	(9)	Capillary length 2	
0		0 mm	only for room thermostat
2000		2000 mm	
			Special length upon request
	(10)	Material of capillary 1	
00		Without capillary	
20		CrNi	Stainless steel
40		Cu	Copper
	(11)	Material of capillary 2	
00		Without capillary	Single thermostat
20		CrNi	Stainless steel
40		Cu	Copper
	(12)	Process connection	
10		Plain cylindrical probe / contact probe	
15		Spiral probe	
35		Thermowell for JUMO heatTHERM with flange and intermediate piece	
76 ^a		Intermediate piece	

^a For process connection 76, select sheath according to data sheet 606710, screw-in sheath "20" U with thread G1/2 made of stainless steel (CrNi).

JUMO GmbH & Co. KG

Delivery address: Mackenrodtstraße 14
36039 Fulda, Germany
Postal address: 36035 Fulda, Germany
Phone: +49 661 6003-0
Fax: +49 661 6003-607
E-mail: mail@jumo.net
Internet: www.jumo.net

JUMO Instrument Co. Ltd.

JUMO House
Temple Bank, Riverway
Harlow - Essex CM20 2DY, UK
Phone: +44 1279 63 55 33
Fax: +44 1279 63 52 62
E-mail: sales@jumo.co.uk
Internet: www.jumo.co.uk

JUMO Process Control, Inc.

8 Technology Boulevard
Canastota, NY 13032, USA
Phone: 315-697-5866
1-800-554-JUMO
Fax: 315-697-5867
E-mail: info@jumo.us
Internet: www.jumo.us



Order details

Surface-mounted thermostat JUMO heatTHERM, type 603070

Order code	(13)	Diameter (probe diameter)
6		∅ 6 mm
17		∅ 17 mm Spiral probe for room thermostat (with process connection 15)
3.5		∅ 3.5 mm (With process connection 35)
	(14)	Capillary insulation
13		PVC hose, black
	(15)	Insulation length (from case)
460		460 mm Special length upon request
	(16)	Probe material 1
20		CrNi Stainless steel
40		Cu Copper
	(17)	Probe material 2
00		Single thermostat
20		CrNi Stainless steel
40		Cu Copper
	(18)	Extra codes^a
000		Without extra codes
402		Case protection type IP54
749		Setting range with 250 angular degrees (only STB/STW)
758		Tightening band for contact probe
061		With UL approval
702		Snap-action switch, gold-plated

^a List extra codes in sequence, separated by commas.

Order code

(1) (2) (3) (4) (5) (6) (7) (8) (9) (10) (11) (12) (13) (14) (15) (16) (17) (18)
6073070 / [] - [] - [] - [] - [] - [] - [] - [] - [] - [] - [] - [] - [] - [] - [] - [] - [] / [] , ...

Order example

603070 / 0001 - 5 - 021 - 671 - 70 - 00 - 2000 - 00 - 40 - 00 - 10 - 6 - 00 - 000 - 40 - 00 / 000^a , ...

^a List extra codes in sequence, separated by commas.

JUMO GmbH & Co. KG
 Delivery address: Mackenrodtstraße 14
 36039 Fulda, Germany
 Postal address: 36035 Fulda, Germany
 Phone: +49 661 6003-0
 Fax: +49 661 6003-607
 E-mail: mail@jumo.net
 Internet: www.jumo.net





JUMO Instrument Co. Ltd.
 JUMO House
 Temple Bank, Riverway
 Harlow - Essex CM20 2DY, UK
 Phone: +44 1279 63 55 33
 Fax: +44 1279 63 52 62
 E-mail: sales@jumo.co.uk
 Internet: www.jumo.co.uk



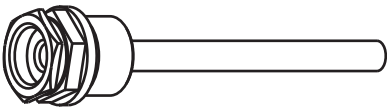

JUMO Process Control, Inc.
 8 Technology Boulevard
 Canastota, NY 13032, USA
 Phone: 315-697-5866
 1-800-554-JUMO
 Fax: 315-697-5867
 E-mail: info@jumo.us
 Internet: www.jumo.us

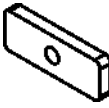



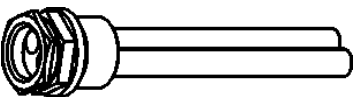

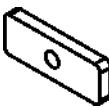
Accessories

(according to product group 606710)

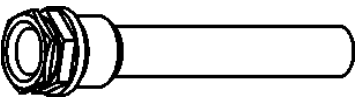
Thermowell set	Thermowell with sealing collar				Clamp for strain relief	Plate for surface-mounted thermostat	Screw for surface-mounted thermostat		
Suitable for 1 probe									
Part no.	Type	Abbreviation	Connection	∅ sleeve × fitting length EL	Material	Pressure loading capacity at +150 °C			
60003177	Thermowell for JUMO heatTHERM, 1 probe	28	G 1/2	8 × 100 mm	Brass/nickel-plated	48 bar			
60003203				8 × 150 mm					
60003171				8 × 200 mm					
60003172				8 × 100 mm	Stainless steel / 1.4571			88 bar	
60003205				8 × 150 mm					
60003173				8 × 200 mm					

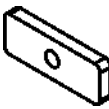
Thermowell set	Thermowell with sealing collar				Clamp for strain relief	Plate for surface-mounted thermostat	Screw for surface-mounted thermostat
Suitable for 2 probes							
Part no.	Type	Abbreviation	Connection	∅ sleeve × fitting length EL	Material	Pressure loading capacity at +150 °C	
60003178	Thermowell for JUMO heatTHERM, 2 probes	29	G 1/2	2 × 8 × 100 mm	Brass / nickel-plated	48 bar	
60003204				2 × 8 × 150 mm			
60003174				2 × 8 × 200 mm			

Thermowell set	Thermowell with sealing collar				Pressure spring	Clamp for strain relief	Plate for surface-mounted thermostat	Screw for surface-mounted thermostat
Suitable for 2 probes								
Part no.	Type	Abbreviation	Connection	∅ sleeve × fitting length EL	Material	Pressure loading capacity at +150 °C		
60003175	Thermowell for JUMO heatTHERM, 2 probes	29	G 1/2	15 × 100 mm	Stainless steel / 1.4571	48 bar		
60003206				15 × 150 mm				
60003176				15 × 200 mm				

Adapter piece for thermowell					Material	
Part no.					Steel / nickel-plated	
60507273						